



Price Index



7 Widths
9 Bending Radii



3 options for interior separation



5 options for mounting brackets



Various strain relief options



Smooth interior for long cable life

Large pins for long service life

Dirt-repellent exterior

Tapered inertion point - easy assembly

Reinforced stop dog

Integrated strain relief possible

Series 240 (snap-open along inner radius) can be combined with Series 250 (snap-open along outer radius)

Snap-open, hinged to left or right, along inner or outer radius, accessible from the top, rather than from the side, of the link

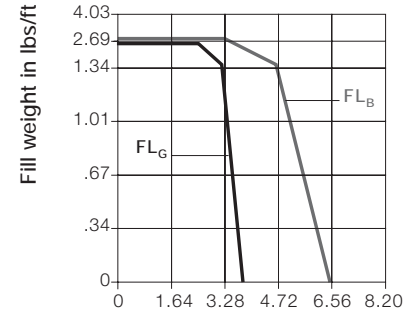

Unsupported length in ft FL_B / FL_G

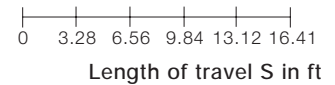

Unsupported length

- FL_B = unsupported with permitted sag
- FL_G = unsupported with straight upper run

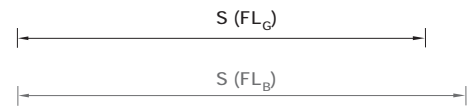
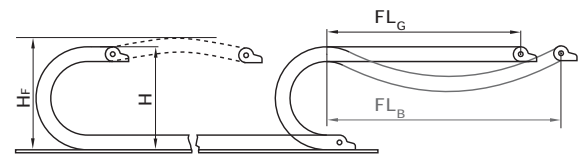

Product Range:

Inner Widths (Bi) inches (mm):	.98 (25), 1.50 (38), 2.24 (57), 3.03 (77), 3.54 (90), 4.06 (103), 4.92 (125)
Bending Radii (R) inches (mm):	2.16 (55), 2.95 (75), 3.94 (100), 4.92 (125), 5.91 (150), 6.89 (175), 7.87 (200), 8.86 (225), 9.84 (250)
Pitch:	1.81 (46 mm)/link = 6.71 links/ft (22 links/m) 39.8 (1012 mm)



When to use the Series 200/240/250:

- If snap-open accessibility along inner or outer radius is required
- If integrated strain relief is required at the mounting point
- If modular interior separation is required
- If long service life is required
- If easy installation is required



When not to use the Series 200/240/250:

- If each link requires snap-open accessibility on both sides simultaneously
 - ▶ System E4, Series 220 etc., Chapter 6
- If maximum stability is required
 - ▶ System E4, Series 220 etc., Chapter 6
- If chip protection is required
 - ▶ Energy Tubes E2, Series R48, Chapter 6
- If the application is very simple
 - ▶ E-Z Chain, Series E 200, Chapter 6

- Accessories for
 - ▶ Guide Troughs, Chapter 9
- Further information
 - ▶ Design, Chapter 1

Unsupported Energy Chains® ▶ Design, Chapter 1, feature positive camber over short travels. This must be accounted for when specifying the clearance height. Please refer to **Installation dimensions** for further details.

If the unsupported length is exceeded, the Energy Chain®/Tube must glide on itself. This requires a guide trough ▶ Design, Chapter 1 or incorporation of igus® exclusive AUTO-GLIDE System guide elements, which are available for this chain series ▶ AUTO-GLIDE System, Chapter 9.

Other Installation Methods:

Vertical, hanging	= max 131 (40 m)
Vertical, standing	= max 9.84 (3 m)
Side-mounted, unsupported	= max 3.28 (1 m)
Rotary	= requires further calculation

- Long travel: Max: 328 ft (100 m)

Series 200/240/250 "E2 medium"



200
240
250

Series 200 Energy Chain®

(non snap-open)

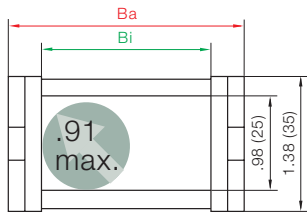

Part No.	Bi	Ba
200-02	.98 (25)	1.61 (41)
200-03	1.50 (38)	2.13 (54)
200-05	2.24 (57)	2.87 (73)
200-07	3.03 (77)	3.66 (93)
200-09	3.54 (90)	4.17 (106)
200-10	4.06 (103)	4.69 (119)
200-12	4.92 (125)	5.55 (141)

Bending Radii
for ALL Widths
2.16 (055)
2.95 (075)
3.94 (100)
4.92 (125)
5.91 (150)
6.89 (175)
7.87 (200)
8.86 (225)
9.84 (250)

Supplement part no. with required radius
for example, 200-02-100-0

Series 240 Energy Chain®

(snap-open along inner radius)

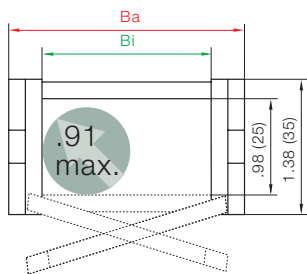

Part No.	Bi	Ba
240-02	.98 (25)	1.61 (41)
240-03	1.50 (38)	2.13 (54)
240-05	2.24 (57)	2.87 (73)
240-07	3.03 (77)	3.66 (93)
240-09	3.54 (90)	4.17 (106)
240-10	4.06 (103)	4.69 (119)
240-12	4.92 (125)	5.55 (141)

Bending Radii
for ALL Widths
2.16 (055)
2.95 (075)
3.94 (100)
4.92 (125)
5.91 (150)
6.89 (175)
7.87 (200)
8.86 (225)
9.84 (250)

Supplement part no. with required radius
for example, 240-02-100-0

Series 250 Energy Chain®

(snap-open along outer radius)

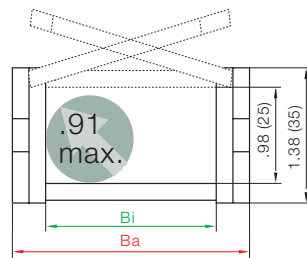

Part No.	Bi	Ba
250-02	.98 (25)	1.61 (41)
250-03	1.50 (38)	2.13 (54)
250-05	2.24 (57)	2.87 (73)
250-07	3.03 (77)	3.66 (93)
250-09	3.54 (90)	4.17 (106)
250-10	4.06 (103)	4.69 (119)
250-12	4.92 (125)	5.55 (141)

Bending Radii
for ALL Widths
2.16 (055)
2.95 (075)
3.94 (100)
4.92 (125)
5.91 (150)
6.89 (175)
7.87 (200)
8.86 (225)
9.84 (250)

Supplement part no. with required radius
for example, 250-02-100-0



! Use Series 250 for gliding applications

Installation Dimensions

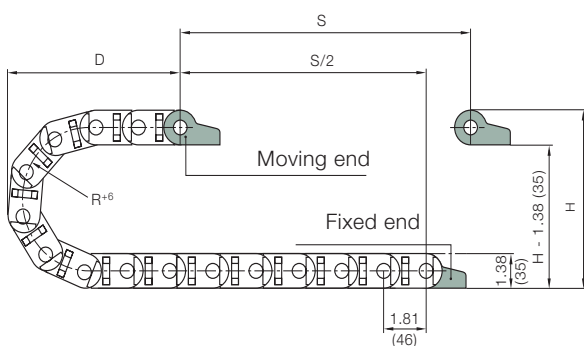

R	2.17 (55)	2.95 (75)	3.94 (100)	4.92 (125)	5.91 (150)
H* ₀	5.71 (145)	7.28 (185)	9.25 (235)	11.22 (285)	13.19 (335)
D	4.92 (125)	5.91 (150)	6.69 (170)	7.68 (195)	8.66 (220)
K	10.87 (276)	13.62 (346)	16.30 (414)	19.53 (496)	22.76 (578)

R	6.89 (175)	7.87 (200)	8.86 (225)	9.84 (250)
H* ₀	15.16 (385)	17.13 (435)	19.09 (485)	21.06 (535)
D	9.65 (245)	10.63 (270)	11.61 (295)	12.60 (320)
K	25.98 (660)	29.21 (742)	32.05 (814)	36.22 (920)

Pitch: = 1.81 (46 mm) per link
 Links per ft (m): = 6.71 (22)
 Chain length: = $\frac{S}{2} + K$

*The required clearance height is HF = H + .98 (25) with 1.01 (1.5 kg/m) fill weight. Please consult igus® if space is particularly restricted.

PDF: www.igus.com/echainpdf.asp
 Specs/CAD/RFQ: www.igus.com/echain.asp
 RoHS info: www.igus.com/RoHS.asp



Interior Separation

Option 1: vertical separators

Separators are the only option when compartmentalizing the interior of the non-snap-open chain (Series 200). If a large distance between separators is required, it is possible to use separators with wide feet (not Series 200) or spacers. Both are predominantly used for side-mounted Energy Chains®.

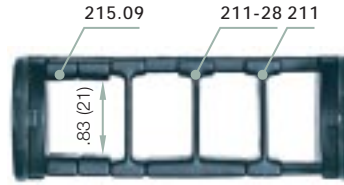

	Spacer		
	Unassembled	Part No. 205-09	
	Assembled	Part No. 215-09	

	Vertical Separator		
	Unassembled	Part No. 201	
	Assembled	Part No. 211	

	Vertical Separators		
	Unassembled	Part No. 201-28	
	Assembled	Part No. 211-28	

Option 2: full-width shelf

This option is available for the snap-open Series 240/250 chains. It is ideal for use in applications involving many thin cables with similar or identical diameters. This shelf slides into place and spans the entire width of the chain.

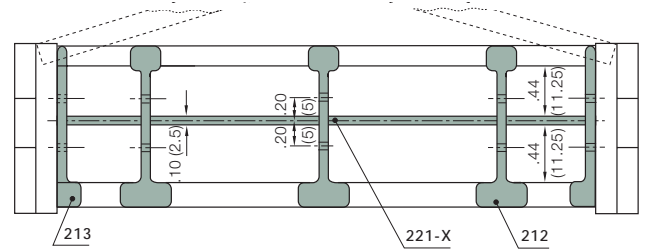
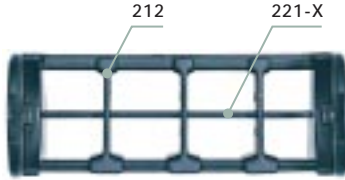

	Vertical Separators, Slotted		
	Unassembled	Part No. 202	
	Assembled	Part No. 212	

	Side Plates		
	Unassembled	Part No. 203	
	Assembled	Part No. 213	

Width X in. (mm)	Part No. Unassembled	Part No. Assembled
.98 (25)	220-25	221-25
1.50 (38)	220-38	221-38
2.24 (57)	220-57	221-57
3.03 (77)	220-77	221-77
3.54 (90)	220-90	221-90
4.06 (103)	220-103	221-103
4.92 (125)	220-125	221-125

Option 3: shelves

This option is available for the Series 240/250 snap-open chains. It is ideal for use in applications involving many cables with different diameters. This option allows for variable compartment heights and widths across the chain width, but can also be used for level separation across the entire width.

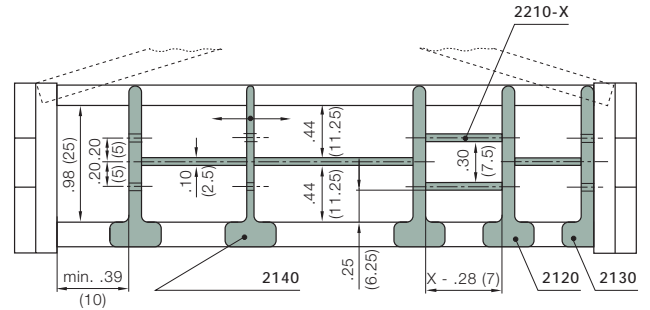
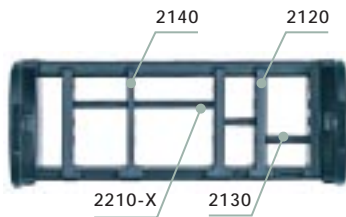

	Vertical Separator		
	Unassembled	Part No. 2040	
	Assembled	Part No. 2140	

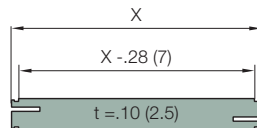

	Vertical Separator		
	Unassembled	Part No. 2020	
	Assembled	Part No. 2120	

	Side Plates		
	Unassembled	Part No. 2030	
	Assembled	Part No. 2130	

Width X in. (mm)	Part No. Unassembled	Part No. Assembled
.71 (18)	2200-18	2210-18
.91 (23)	2200-23	2210-23
1.10 (28)	2200-28	2210-28
1.30 (33)	2200-33	2210-33
1.50 (38)	2200-38	2210-38
1.69 (43)	2200-43	2210-43
1.89 (48)	2200-48	2210-48
2.28 (58)	2200-58	2210-58
2.68 (68)	2200-68	2210-68
2.87 (73)	2200-73	2210-73
3.46 (88)	2200-88	2210-88
3.90 (99)	2200-99	2210-99
4.88 (124)	2200-124	2210-124

igus® Energy Chain
Systems®

Telephone 1-800-521-2747
Fax 1-401-438-7270

Internet: <http://www.igus.com>
email: sales@igus.com
QuickSpec: <http://www.igus.com/qs/echain.asp>

Series 200/240/250 E2 "medium"



200
240
250

Mounting Brackets

Option 1: pivoting

- Pivoting
- Short and long travel
- Space-restricted conditions
- Corrosion-resistant

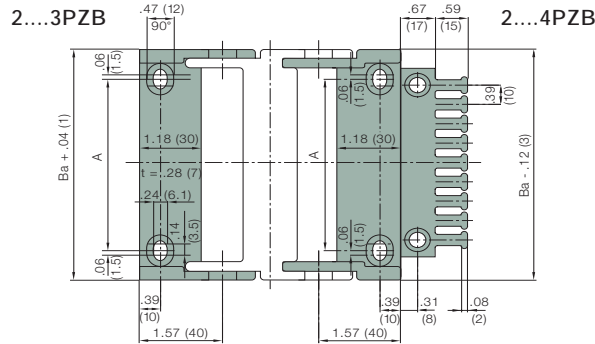
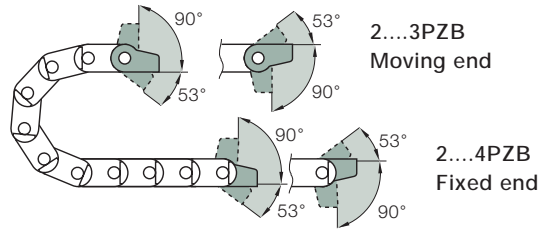

Chain Type	Part No. Full Set with Tiewrap Plates	Part No. Set with Tiewrap Plates and 10 Cable Tiewraps	Part No. Mounting Bracket Set	Dimension A in. (mm)
200/240/250-02	2020-34PZB	2020-34PZBK1	2020-34PZ	.47 (12)
200/240/250-03	2030-34PZB	2030-34PZBK1	2030-34PZ	.98 (25)
200/240/250-05	2050-34PZB	2050-34PZBK1	2050-34PZ	1.73 (44)
200/240/250-07	2070-34PZB	2070-34PZBK1	2070-34PZ	2.52 (64)
200/240/250-09	2090-34PZB	2090-34PZBK1	2090-34PZ	3.03 (77)
200/240/250-10	2100-34PZB	2100-34PZBK1	2100-34PZ	3.54 (90)
200/240/250-12	2125-34PZB	2125-34PZBK1	2125-34PZ	4.41 (112)



2...34 PZB = Full set, each part with pin/bore, including tiewrap plates
 2...3 PZB = Mounting bracket with bore, including tiewrap plates
 2...4 PZB = Mounting bracket with pin, including tiewrap plates

Option 2: locking

- Locked connections
- Vertical hanging/standing travels
- Extreme accelerations
- Corrosion-resistant

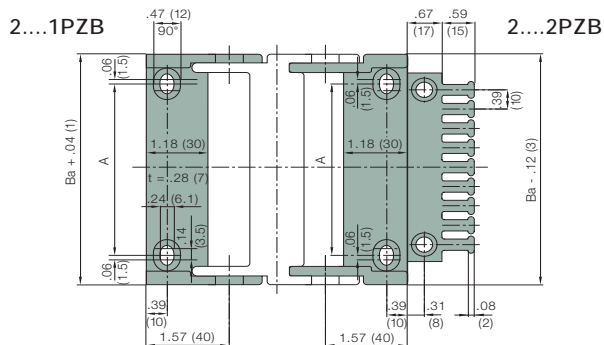
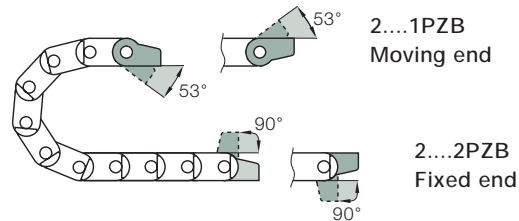

Chain Type	Part No. Full Set with Tiewrap Plates	Part No. Set with Tiewrap Plates and 10 Cable Tiewraps	Part No. Mounting Bracket Set	Dimension A in. (mm)
200/240/250-02	2020-12PZB	2020-12PZBK1	2020-12PZ	.47 (12)
200/240/250-03	2030-12PZB	2030-12PZBK1	2030-12PZ	.98 (25)
200/240/250-05	2050-12PZB	2050-12PZBK1	2050-12PZ	1.73 (44)
200/240/250-07	2070-12PZB	2070-12PZBK1	2070-12PZ	2.52 (64)
200/240/250-09	2090-12PZB	2090-12PZBK1	2090-12PZ	3.03 (77)
200/240/250-10	2100-12PZB	2100-12PZBK1	2100-12PZ	3.54 (90)
200/240/250-12	2125-12PZB	2125-12PZBK1	2125-12PZ	4.41 (112)

2...12 PZB = Full set, each part with pin/bore, including tiewrap plates
 2...1 PZB = Mounting bracket with bore, including tiewrap plates
 2...2 PZB = Mounting bracket with pin, including tiewrap plates

PDF: www.igus.com/echainpdf.asp
 Specs/CAD/RFO: www.igus.com/echain.asp
 RoHS info: www.igus.com/RoHS.asp



Mounting Brackets

Option 3: KMA pivoting

- Pivoting
- Short travels
- Space-restricted conditions
- Corrosion-resistant
- Bolted connection outside of chain cross-section

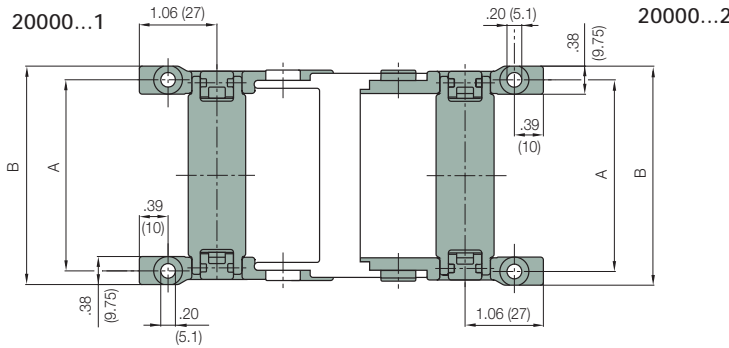
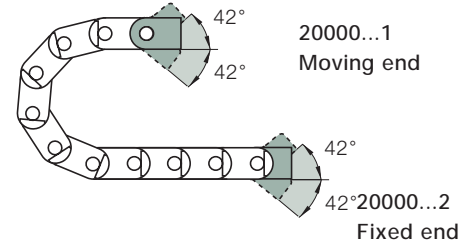

• Stackable



Chain Type	Part No. Full Set	Dimension A		Dimension B	
		in.	(mm)	in.	(mm)
200/240/250-02	20000-02-12	1.36	(34.5)	1.73	(44)
200/240/250-03	20000-03-12	1.87	(47.5)	2.24	(57)
200/240/250-05	20000-05-12	2.62	(66.5)	2.99	(76)
200/240/250-07	20000-07-12	3.41	(86.5)	3.78	(96)
200/240/250-09	20000-09-12	3.92	(99.5)	4.29	(109)
200/240/250-10	20000-10-12	4.43	(112.5)	4.80	(122)
200/240/250-12	20000-12-12	5.30	(134.5)	5.67	(144)

21000...12 = Full set, each with pin/bore
21000...1 = Mounting bracket with bore
21000...2 = Mounting bracket with pin

Option 4: KMA locking

- Locked connections
- Vertical hanging/standing travels
- Extreme accelerations
- Corrosion-resistant
- Bolted connection outside of chain cross-section

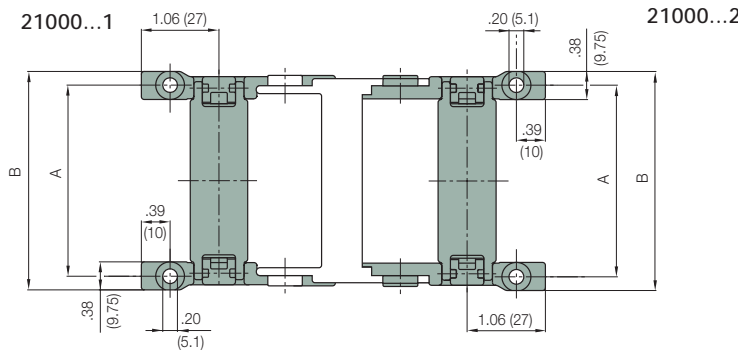
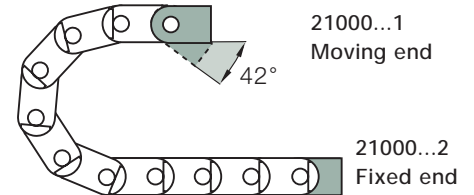

• Stackable



Chain Type	Part No. Full Set	Dimension A		Dimension B	
		in.	(mm)	in.	(mm)
200/240/250-02	21000-02-12	1.36	(34.5)	1.73	(44)
200/240/250-03	21000-03-12	1.87	(47.5)	2.24	(57)
200/240/250-05	21000-05-12	2.62	(66.5)	2.99	(76)
200/240/250-07	21000-07-12	3.41	(86.5)	3.78	(96)
200/240/250-09	21000-09-12	3.92	(99.5)	4.29	(109)
200/240/250-10	21000-10-12	4.43	(112.5)	4.80	(122)
200/240/250-12	21000-12-12	5.30	(134.5)	5.67	(144)

21000...12 = Full set, each with pin/bore
21000...1 = Mounting bracket with bore
21000...2 = Mounting bracket with pin

Mounting Brackets

Option 5: Steel

- One part for all chain widths
- Electrically conductive

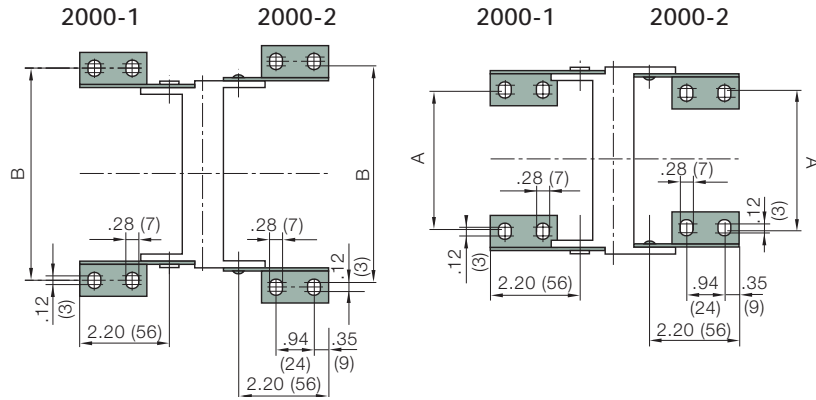
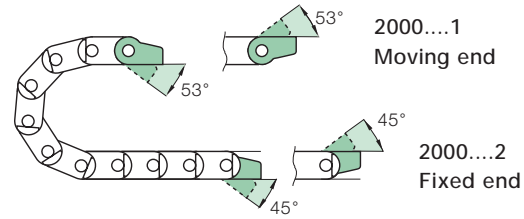

Chain Type	Part No. Full Set	Dimension A		Dimension B	
		in.	(mm)	in.	(mm)
200/240/250-02	2000-12	-	-	2.36	(60)
200/240/250-03	2000-12	.98	(25)	2.87	(73)
200/240/250-05	2000-12	1.73	(44)	3.62	(92)
200/240/250-07	2000-12	2.52	(64)	4.41	(112)
200/240/250-09	2000-12	2.99	(76)	4.88	(124)
200/240/250-10	2000-12	3.54	(90)	5.43	(138)
200/240/250-12	2000-12	4.41	(112)	6.30	(160)

2000-12 = Full set, 4 parts,
2 with pin, 2 with bore
2000-1 = Mounting bracket with bore,
1 part left/right
2000-2 = Mounting bracket with pin,
1 part left/right

Strain Relief for Polymer Mounting Brackets (pivoting or locking)

The strain relief tiwrap plates can be snapped directly onto the mounting bracket without additional hardware. When the mounting brackets are bolted into place, the tiwrap plates are also connected firmly to the machine surface. No separate installation is necessary. Cable tiwraps secure cables using the "teeth" of the tiwrap plate for time-saving, effective strain relief.



Strain relief for KMA and steel mounting brackets

With these mounting brackets, strain relief tiwrap plates may be bolted into the bores in front of the mounting bracket.



Tiwrap plate as an individual part

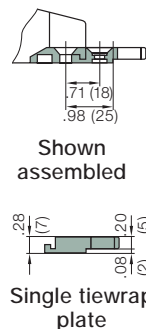
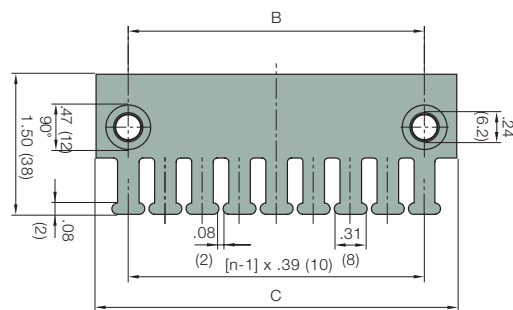

Tiwrap Plates	n Number of Teeth	C Overall Width	B Distance Between Bore Holes
2020-ZB	3	1.18 (30)	.59 (15)
2030-ZB	4	1.57 (40)	.79 (20)
2040-ZB	5	1.97 (50)	1.18 (30)
2050-ZB	6	2.36 (60)	1.57 (40)
2070-ZB	8	3.15 (80)	2.36 (60)
2090-ZB	9	3.54 (90)	2.76 (70)
2100-ZB	10	3.94 (100)	3.15 (80)
2120-ZB	12	4.72 (120)	3.94 (100)

Cable tiwraps as individual parts

Cable tiwraps 100 pieces/bag	Width x Length		Maximum Ø		Tensile Strength	
	in.	(mm)	in.	(mm)	lbs	(N)
CFB-001	.19 x 5.91	(4.8 x 150)	1.42	(36)	50	(222)

- Other strain relief elements
- ▶ Strain Relief, Chapter 10

PDF: www.igus.com/echainpdf.asp
Specs/CAD/RFO: www.igus.com/echain.asp
RoHS info: www.igus.com/RoHS.asp



Order example

250-10

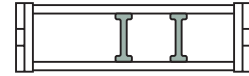
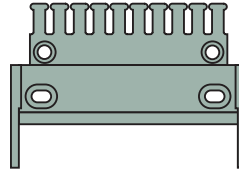
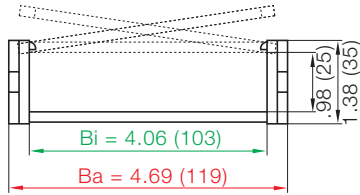

1. Chain selection:

250-10-100-0



2. Mounting brackets:

2100-34-PZB

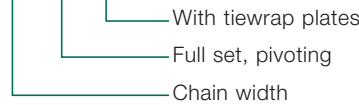

3. Interior separation:

2 separators, unassembled, (Part No. 201), or assembled every other link (Part No. 211).
Alternative interior separation configuration according to design layout possible.

4. Additional information on guide troughs ► Chapter 9

For 16.4 ft (5 m) chain, color black, with pivoting mounting brackets
16.4 ft (5 m) 250-10-100-0 and 2100-34PZ

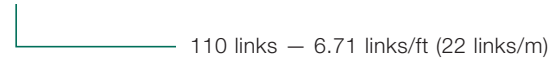

Technical data

Chain Type	Weight Per Link		Weight	
	(oz.)	(g)	(lbs/ft)	(kg/m)
200/240/250-02	0.074	(0.034)	0.50	(0.74)
200/240/250-03	0.081	(0.037)	0.54	(0.81)
200/240/250-05	0.090	(0.041)	0.60	(0.90)
200/240/250-07	0.101	(0.046)	0.68	(1.01)
200/240/250-09	0.115	(0.052)	0.73	(1.08)
200/240/250-10	0.128	(0.058)	0.77	(1.15)
200/240/250-12	0.141	(0.064)	0.82	(1.22)

Material	igumid G
Permitted temperature	-40°/+266°F (-40°/+130°C)
Gliding speed max.	16.4 ft/s (5 m/s)
Unsupported V max.	32.8 ft/s (10 m/s)
Flammability class	VDE 0304 IIC UL94 1H

- Details of material properties
- Design, Chapter 1

Guide Troughs



- Other technical data on guide troughs

► Chapter 9

Series 200/240/250 E2 "medium"

Assembly Instructions



1. To open crossbars: press screwdriver into tab on top of link, lever screwdriver until crossbar opens



2. Repeat Step 1 on other side



3. To close crossbars: push down on crossbar with thumb until it snaps into place



4. Joining chain sections: push sections together; angle one side until pin snaps into bore; repeat on other side



5. Separating chain sections: insert screwdriver between two links



6. Twist until pin disengages from bore; pull sections apart



7. Attaching mounting brackets: snap bracket into link (see Step 4 - "Joining chain sections")



8. Snap tiewrap plate into bottom groove of the mounting bracket

Guide Troughs

Guide troughs are used with applications where the upper run of the Energy Chain® glides on the lower run. If using igus® steel guide troughs, the following components are required:

- Full travel length of guide trough
Part Number 92-30
- 1/2 travel length of glide bars
Part Number 92-01
- Installation sets as end connectors
Part Number 92-50-XX

-XX indicates the length of the profile rail on which the guide trough is mounted. The values and part numbers are specified in the table on the left. The standard length of the trough components and glide bars is 6.56 ft (2 m.) The required overall length of the guide trough directly correlates to the length of travel.

Example:
Length of travel 164 ft (50 m)
Center mounted
Required guide troughs:
164 ft (50 m) guide trough
82 ft (25 m) glide bar
= 25 sections of 6.56 ft
(2 m) guide trough
Part No. 92-30
= 13 sections of 6.56 ft (2 m) glide bar
Part No. 92-01

Required number of installation sets:
= Number of guide trough components + 1
= 25 + 1 = 26
Part number of the installation sets

Example: 92-50-400 for 15.75" (400 mm) long profile rail.



Width of Crossbar
250-05-200-0

	B_{Ri}	Installation Part No.
-02	1.81 (46)	92-50-150
-03	2.32 (59)	92-50-175
-05	3.07 (78)	92-50-175
-07	3.86 (98)	92-50-200
-09	4.37 (111)	92-50-250
-10	4.88 (124)	92-50-250
-12	5.75 (146)	92-50-300

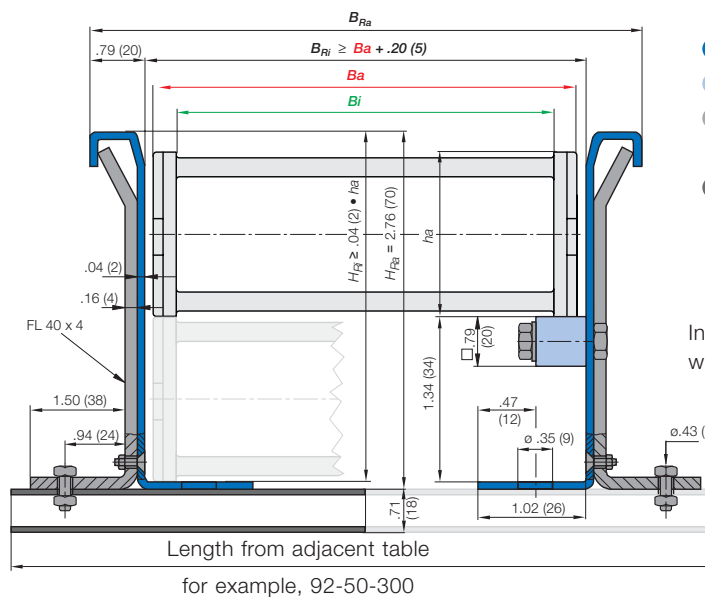

- Guide trough
- Glide bars
- Installation set "Basic"
- C-profile rail

Individual attachment without profile rail

* Specialized guide trough available upon request

Standard length profile rail

